

APPLICATION NOTE	AN-Lift2-0002v100EN
Brake monitoring function for UCM compliance (Lift safety standards)	

Inverter type	FRENIC-Lift (LM2A)
Software version	Software version L2S1_02030970 or later
Required options	Not needed
Related documentation	DESIGN REQUEST DR-LIFT2_0008v104EN
Author	Jaume Alonso
Use	Public, web
Date	16/01/2015
Version	1.0.0
Languages	English

1. Introduction

From January 2012 lift standard EN 81-1:1998+A3:2009 has to be applied. A3 addendum is related to Unintended Car Movement (UCM).

In case of electrical traction lifts, one possible solution to fulfill the new A3 addendum of the EN81-1 standard, is to use the two brakes certified according to this standard and additionally monitor their status individually, by using one limit switch for each brake that detects the actual brake status (released or applied). If the detected brake status is not correct the operation of the elevator must be prevented.

This function is as well applicable to the new lift standards EN 81-20:2014 and EN81-50:2014.

On this application note, it is explained how to program and use a specific function for brake monitoring signals (BRKE1, BRKE2).

2. How to recognize inverters which UCM function available

Basically, all standard family of FRENIC-Lift inverter (LM2A Shipping destination Europe), with the software number mentioned on the description of the document (or later versions), will have this function available. There are two name plates on the inverter where inverter type is written. Both name plates are shown in figure 1.

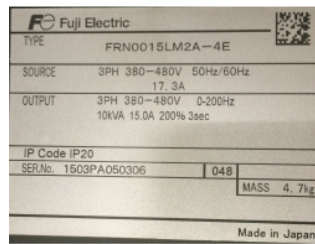

(a) Main Name plate



(b) Sub Name plate

Figure 1. Inverter name plate.

The position where each name plate is placed is shown on figures 2, 3 and 4.

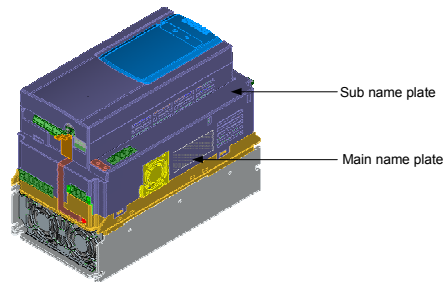

Figure 2. Name plate position in capacities from 0006 to 0032.

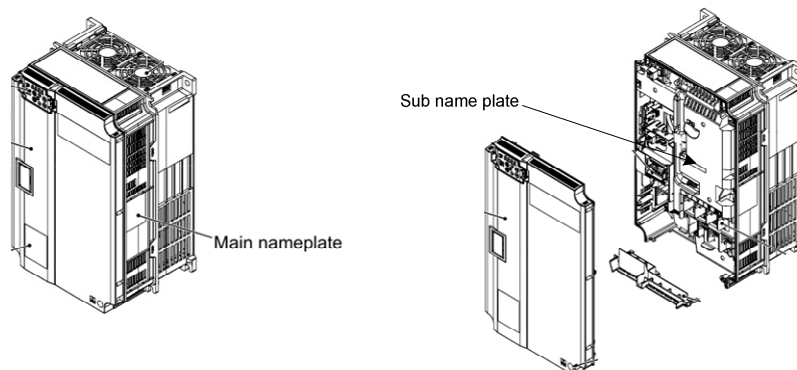

Figure 3. Name plate position in capacities from 0039 to 0045.

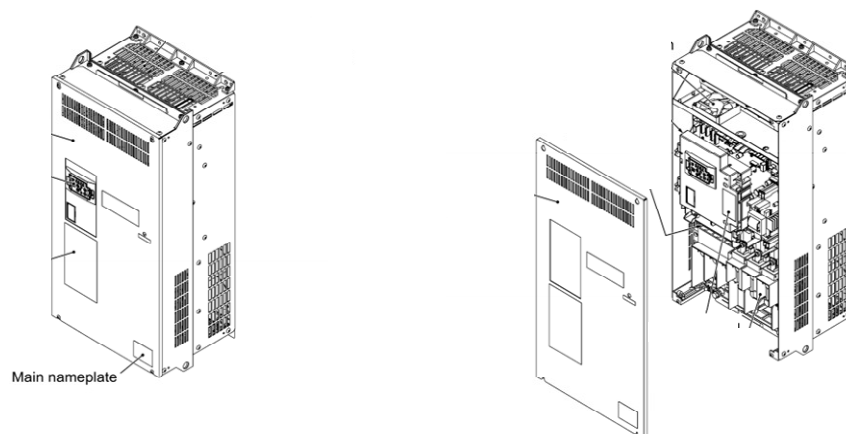
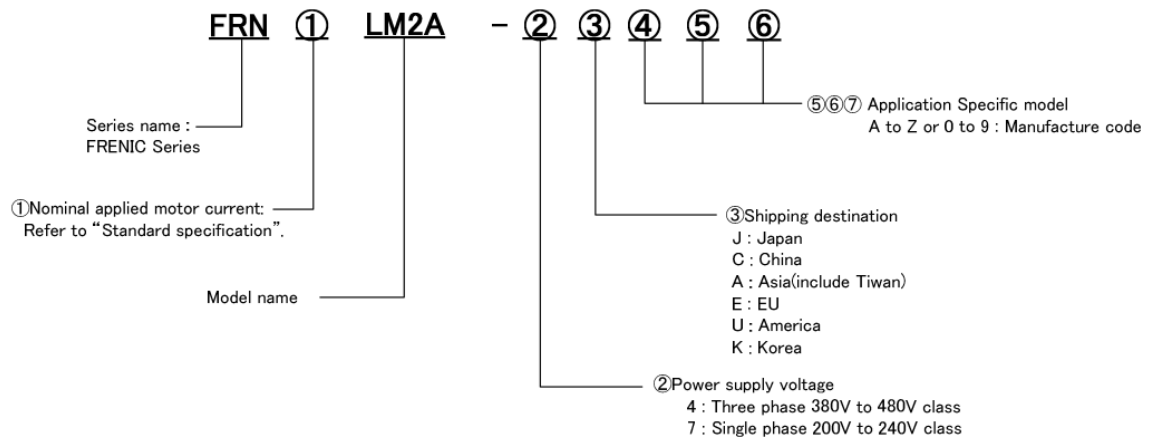

Figure 4. Name plate position in capacities from 0060 to 0091.

So, according to this, FRENIC-Lift (LM2A) types which include this function can be recognized by the below type code.



Software version (Inverter ROM version) can be checked on Menu PRG>3>3 (PRG/INV Info/Maintenance) on page 8/9 as it is shown on figure 5.

PRG>3>3[8/9]		
ROM Number		
Main	0203	← Inverter ROM version
KP	7106	← Keypad ROM version
OpA	0000	← Option ROM version (A-port)
---	---	-----
OpC	0000	← Option ROM version (C-port)

Figure 5. Page 8 of PRG>3>3 on TP-A1-LM2.

As mentioned before, software can be updated, so this number might be different. In this case, software version will have a higher number.

3. FRENIC-Lift basic diagram

On the figure 6, it is shown a basic diagram of the inverter.

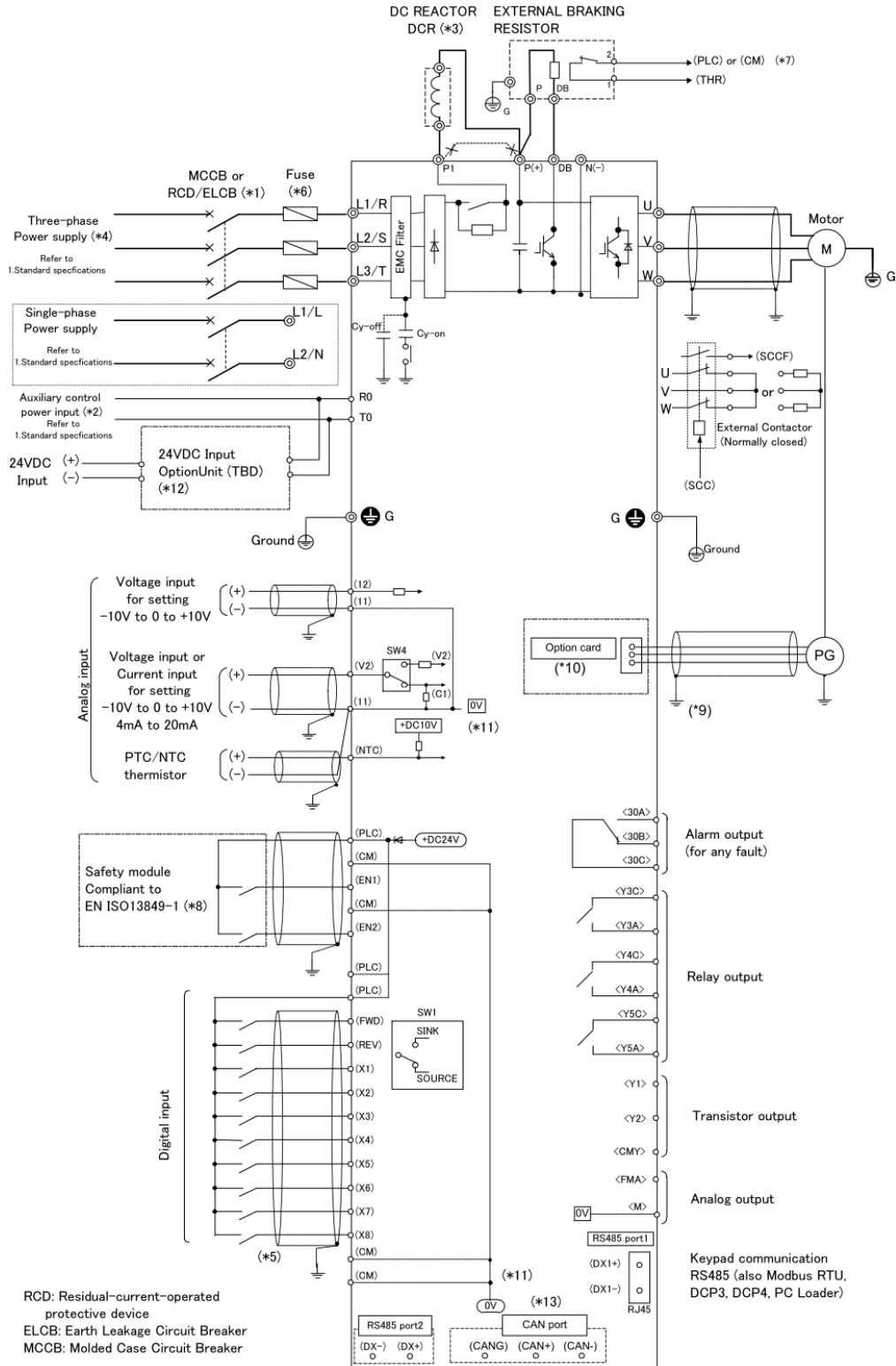

Figure 6. Basic diagram of the inverter.

4. Description of the function and parameters

The parameters and functions related are shown in table 1:

Table 1. Parameters and functions related to UCM function.

Function Code	Name	Setting range	Symbol	Unit	Default setting
E01 to E08, E98 and E99	Command Assignment [X1] to [X8], [FWD] and [REV]	0 to 112 (1000 to 1112) 111(1111): Check Brake Control 1	BRKE1	-	-
		112(1112): Check Brake Control 2	BRKE2	-	-
		114(1114): Rescue operation by external brake control active	RBrk	-	-
E20 to E24, and E27	Signal Assignment to [Y1] to [Y4], [Y5A/C] and [30A/B/C]	0 to 116 (1000 to 1116) 57(1057): Brake Control	BRKS	-	-
H95	<i>bbE</i> alarm reset	0 to 255	-	-	0
H96	Check brake control select	0 to 1 0: BRKE 1: BRKE1/2	-	-	0
L84	Brake control (Brake check time)	0.00 to 10.00 s	-	s	0.00

This function is not active in factory default settings. It means that this function has to be activated. The parameter used to activate this function is **H96**. The functionality of **H96** is explained below.

On the other hand, if Rescue operation by external brake control is active (input function programmed with the value 114(**RBrk**)) brake monitoring function is disabled even **H96**=1. This allows end user to perform a rescue operation by brake control (gravity movement) independently of the inverter, in other words, without looking the inverter due to *bbE* alarm.

a) When **H96** = 0

Even **BRKE1** and **BRKE2** functions are correctly programmed and wired, monitoring function for UCM is not active. BRKE function can be used. For additional information, please, refer to FRENIC-Lift Reference Manual (LM2A).

b) When **H96** = 1

Brake monitoring operation is performed by **BRKE1** and **BRKE2** according to UCM. When the status of **BRKE1** and **BRKE2** doesn't match with **BRKS**, timer of brake check time (**L84**) starts. *bbE* alarm is generated when **BRKE1** or **BRKE2** state remains not matching with **BRKS** during the time specified in **L84**. During lift travel, alarm is not issued, alarm is generated as soon as **BRKS** function is OFF and **L84**

timer passes. For additional details, please refer to chapter “5. Function behavior”.

5. Function behaviour

On the following figures, each possible scenario using **BRKE1** and **BRKE2** functions are explained.

- a) Brake feedback is not matching with brake control signal at starting of the second travel

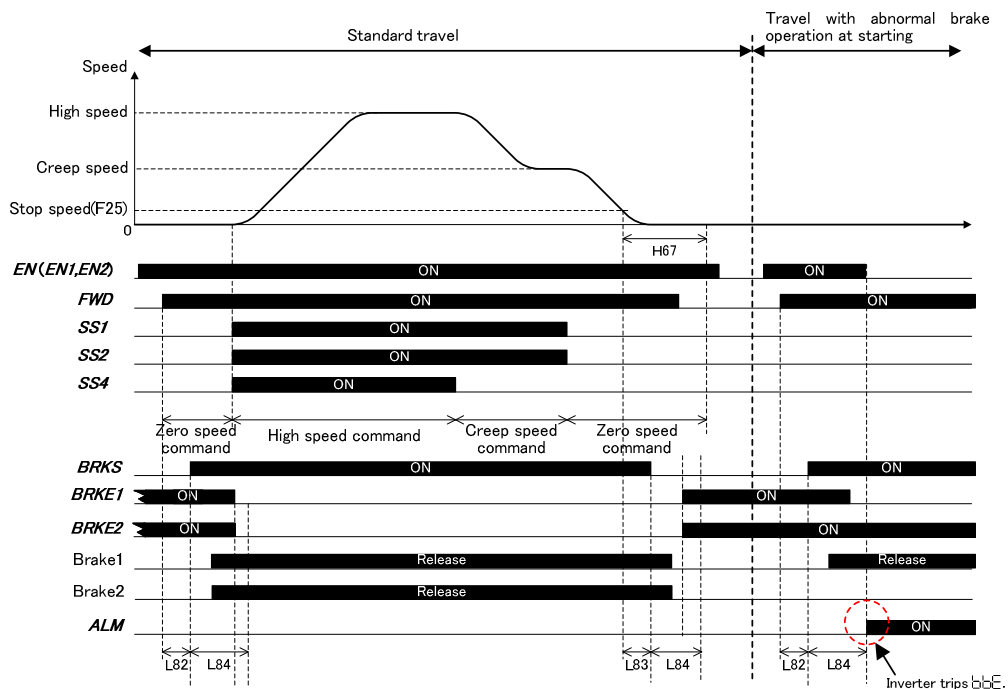

Figure 7. b6E alarm at starting of second travel.

On figure 7, a standard travel is shown, as brake status is matching with brake control signal, inverter is not tripping. On the other hand, when second travel starts, as brake 2 doesn't open, inverter trips b6E after L84 time.

b) Brake feedback is not matching with brake control signal at stopping

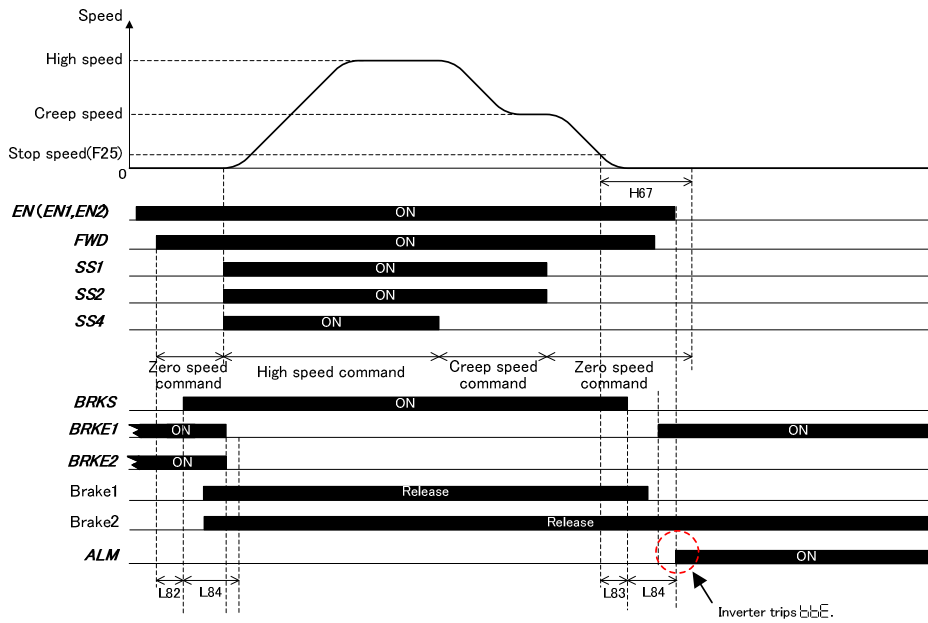

Figure 8. $bbbE$ alarm at stopping.

As it can be observed in figure 8, inverter is tripping $bbbE$ alarm at stop, because brake 2 remains open.

c) Brake feedback is not matching with brake control signal during travel

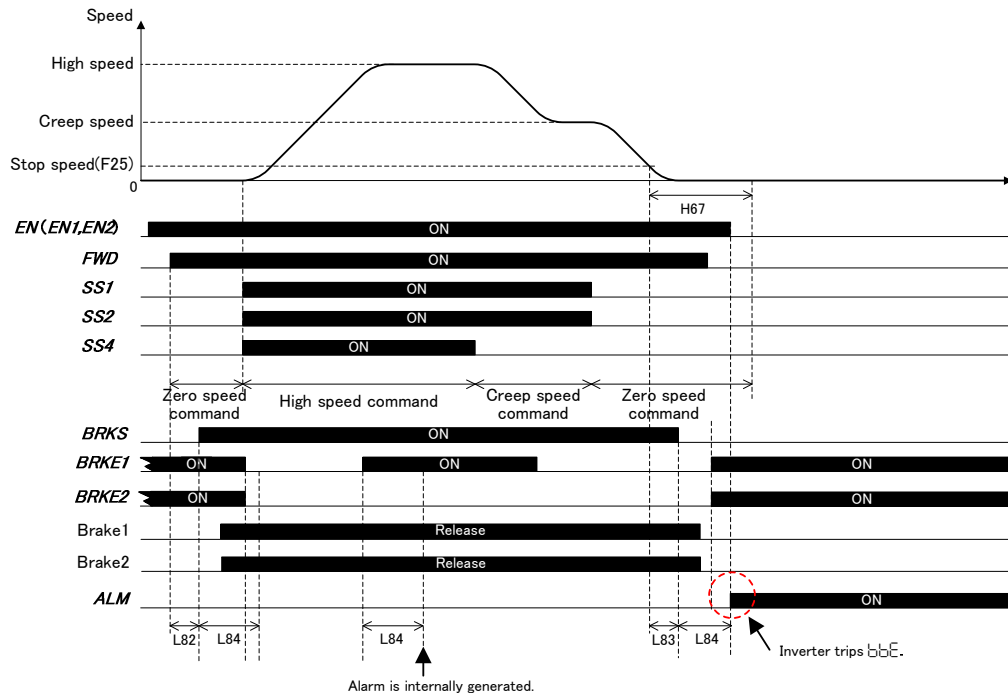

Figure 9. $bbbE$ alarm at stopping because BRKE1 signal is not matching with brake control signal during travel.

As it can be observed in figure 9, brake 1 feedback contact is not working properly, even brake remains open, shows for a certain time during travel that it is closed. After time on **L84** elapses, inverter generates internally an alarm that is shown at the end of the travel.

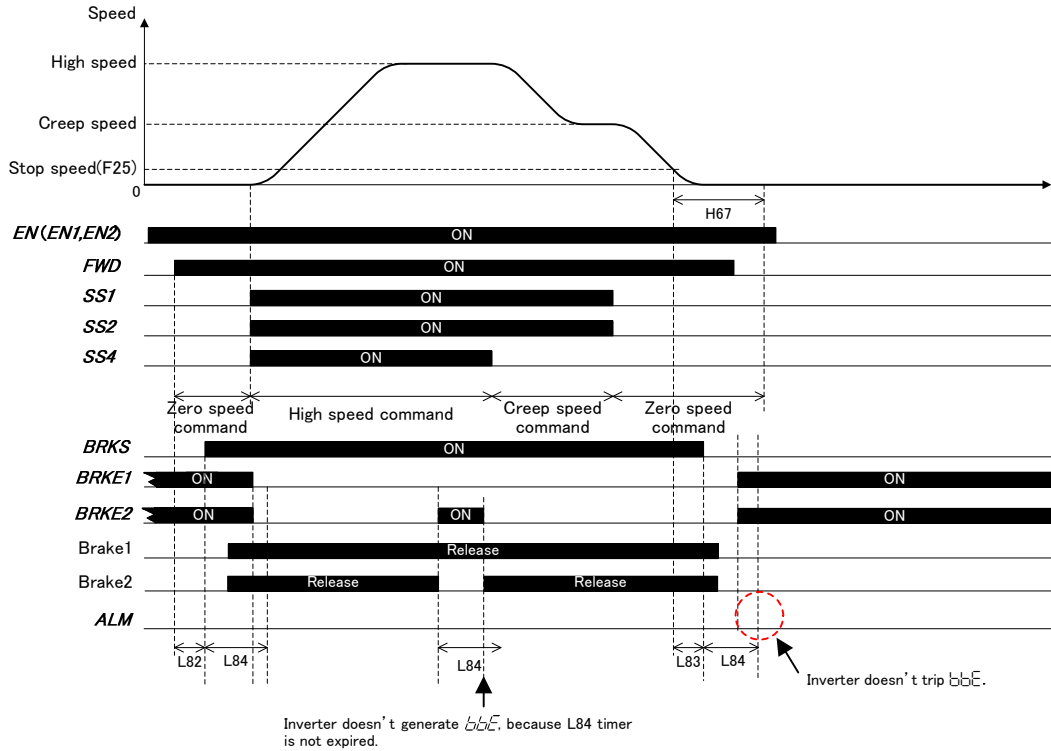

Figure 10. bBE alarm does not appear at stopping even BRKE2 signal was missing.

In case of figure 10, brake 2 is not working properly for a while, even so, as brake recovers before **L84** time, no alarm is generated.

- d) Brake feedback is abnormal when motor is stopped. In this case there are two possibilities, with or without **RBrk** function active (Rescue operation by external brake control active).

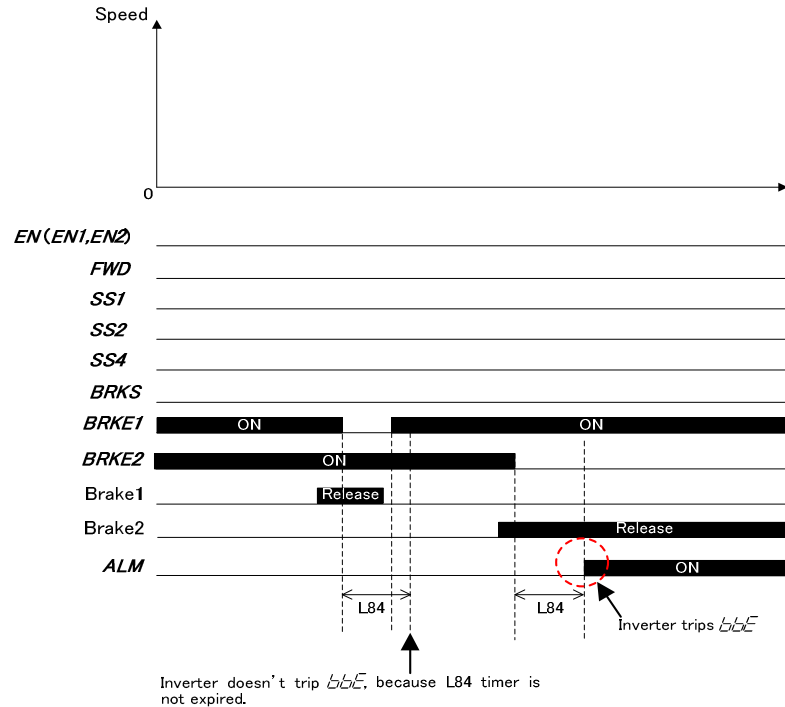

Figure 11. bbf alarm while motor is stopped and **RBrk** function is not used

As it can be observed in figure 11, somebody or something is opening the brake even inverter is not asking to do so. If the brake remains open more than time specified in **L84** timer, inverter trips bbf alarm.

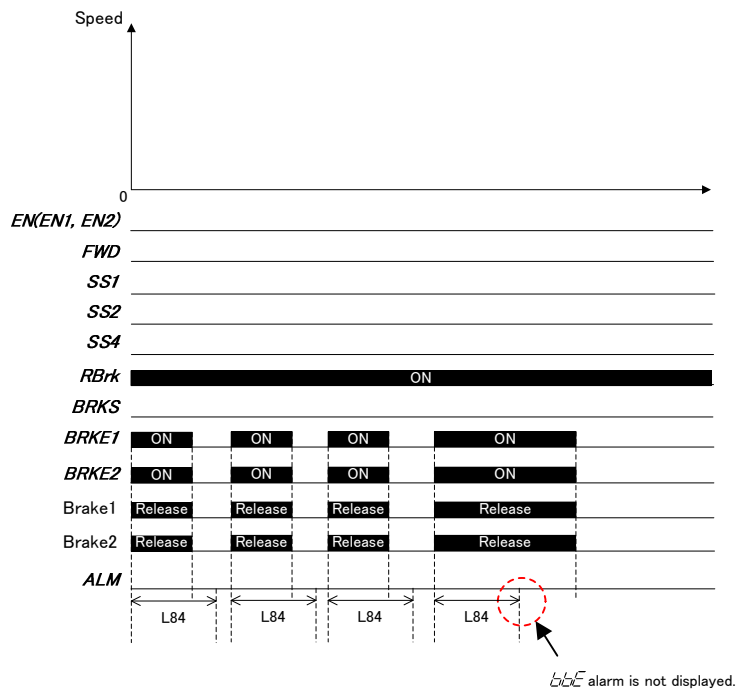

Figure 12. $\overline{b b E}$ alarm while motor is stopped and **RBrk** function is used

As it can be observed in figure 12, somebody or something is opening the brake even inverter is not asking to do so. But in this case, because **RBrk** input function is activated, inverter is not tripping any alarm. When **RBrk** input is activated, inverter understands that brake is being opened by external means in order to rescue people from car. As this is understood as an exceptional operation, $\overline{b b E}$ alarm is not displayed.

6. Example of wiring and setting

Figure 13 shows an example of connection. On this example, there is a motor with two brakes (brake 1 and brake 2). Each brake has a normally closed switch; it means that when brake is closed, switch is closed. In this case terminal **X6** is programmed with function **BRKE1** and **X7** is programmed with function **BRKE2**.

Additionally, a relay output (**Y5A/C**) is programmed to control the brake with the function **BRKS**.

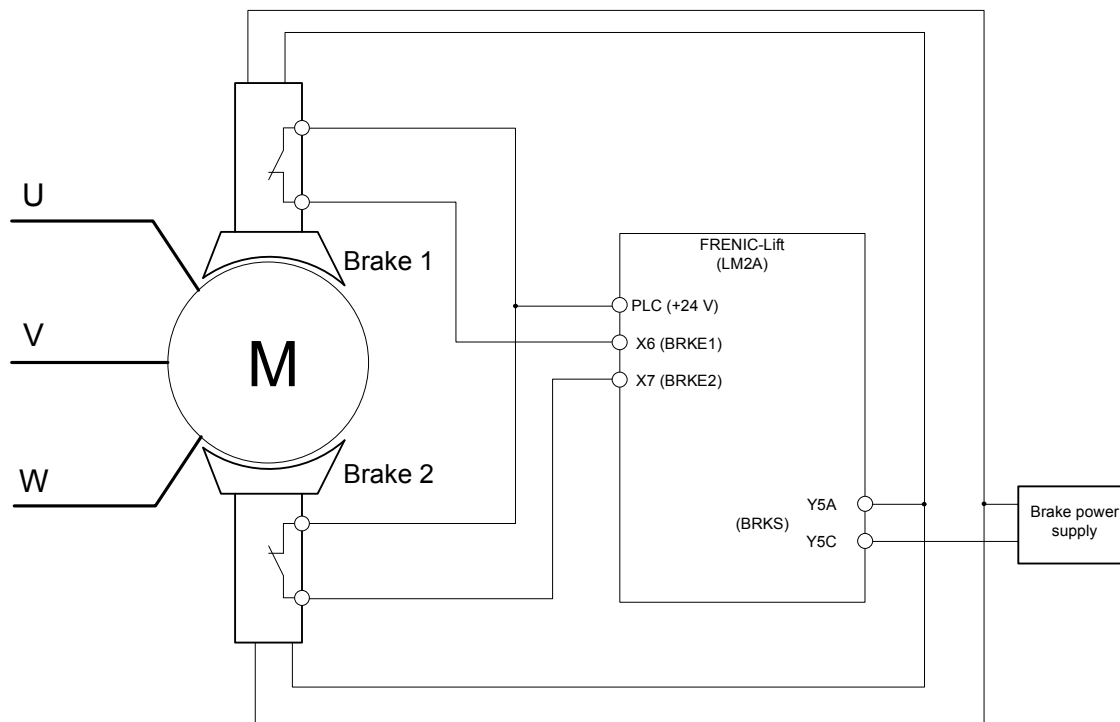

Figure 13. Example of monitoring and control of the brake done by the inverter.

According to figure 13, related parameters have to be set as described in table 3.

Table 2. Parameters setting according to figure 12 example.

Parameter	Name	Setting
E06	Terminal [X6]	111
E07	Terminal [X7]	112
H96	Check brake control select	1
L84	Brake control (Brake check time)	1.00 s

7. Alarm reset and alarm messages related

As explained before, there is a specific alarm for this function. Also, on the existing alarm E_{rE} , a SUB code is added. In table 3, additional information for each alarm is shown.



On same table, SUB codes for alarm b_{bE} are shown as well.

Table 3. Alarm and SUB codes.

Alarm message displayed	SUB code	Description	Possible causes
<i>E-6</i>	14	H96 is set to 1 but some settings related are missing.	Check that BRKE1 function is correctly set. Check that BRKE2 function is correctly set. Check that BRKS function is correctly set.
<i>bbE</i>	11	BRKE1 signal is abnormal.	Check status of micro switch in brake 1. Check status of brake 1 and its power supply. Check status of inverter input/output related to brake 1. Check L84 time.
	12	BRKE2 signal is abnormal.	Check status of micro switch in brake 2. Check status of brake 2 and its power supply. Check status of inverter input/output related to brake 2. Check L84 time.

Because *bbE* alarm blocks the inverter according to UCM, it cannot be reset following the standard procedure. Additionally *bbE* alarm cannot be auto reset by the inverter (**H04**, **H05**), neither can be reset by switching OFF and switching ON inverter's power supply.

In order to reset the alarm, following procedure has to be done:

1. Set parameter **H95** to 111. Cursor can be moved by arrow buttons.
2. Push  button. H95 reverts to 0 automatically.
3. Push  button until main screen is shown. In main screen *bbE* alarm is shown.
4. Push  button.
5. *bbE* alarm disappears from the display.

bbE can only be reset after the cause of the problem has been fixed.

8. Function test procedure.

According to the standard, each time that a new lift is tested, this function has to be also tested. On the following charts, it is explained how to test the function. In order to make the chart more understandable, as a reference it is taken the example shown on figure 13. In case of using a NO contactor, test has to be done removing the cable from the terminal.

TEST OF BRKE1 FUNCTION

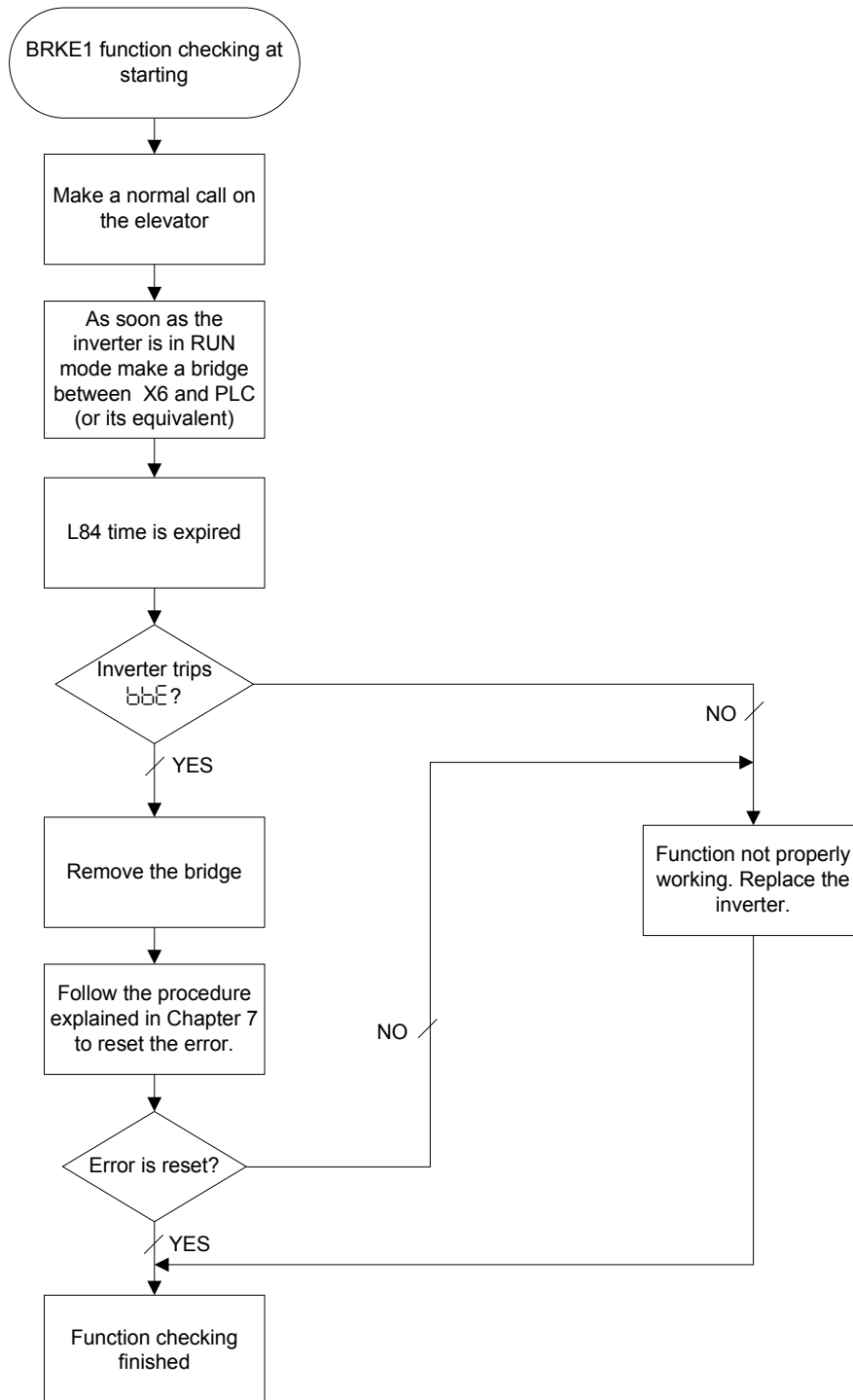

Figure 14. Test of BRKE1 function at starting.

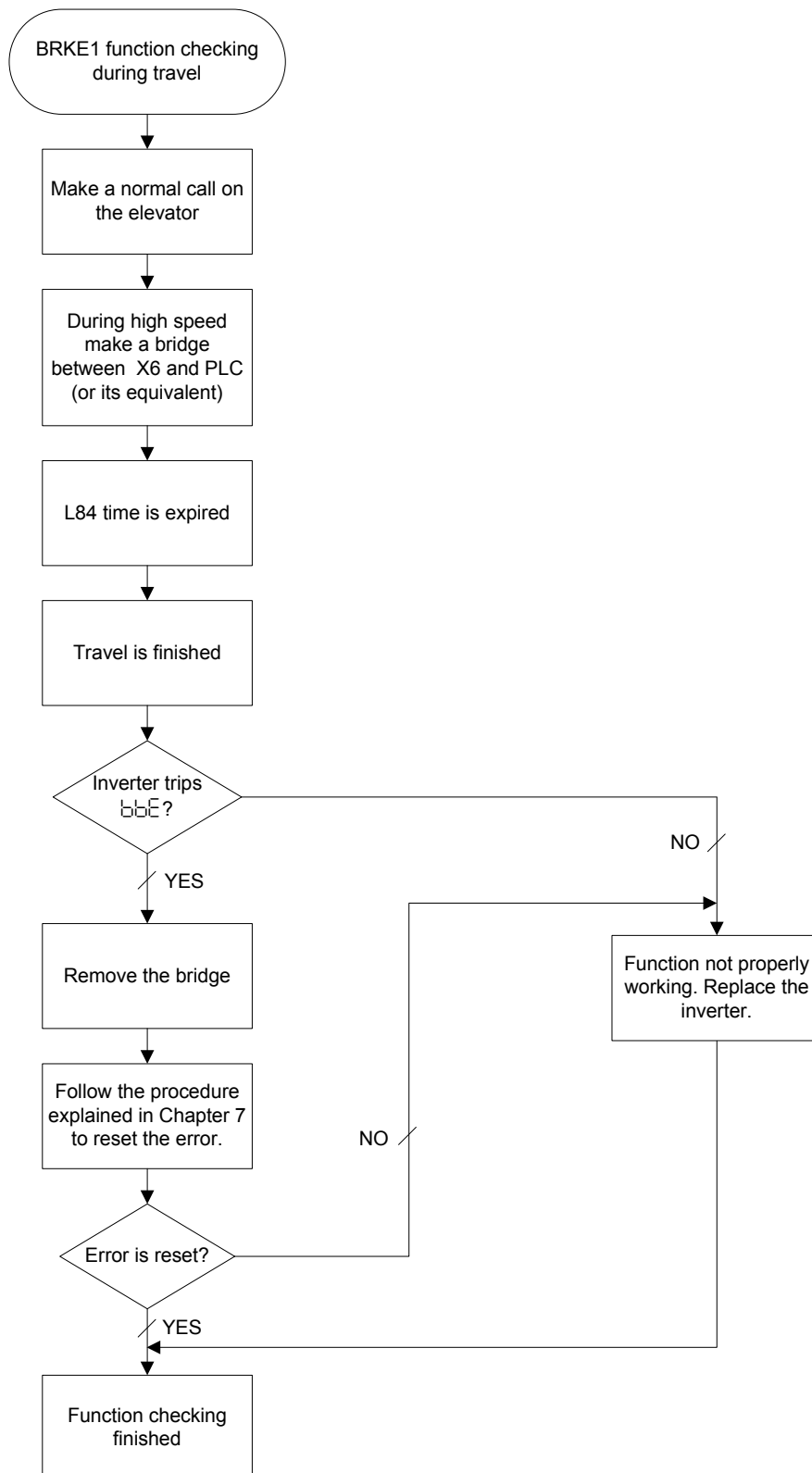

Figure 15. Test of BRKE1 function during normal travel.

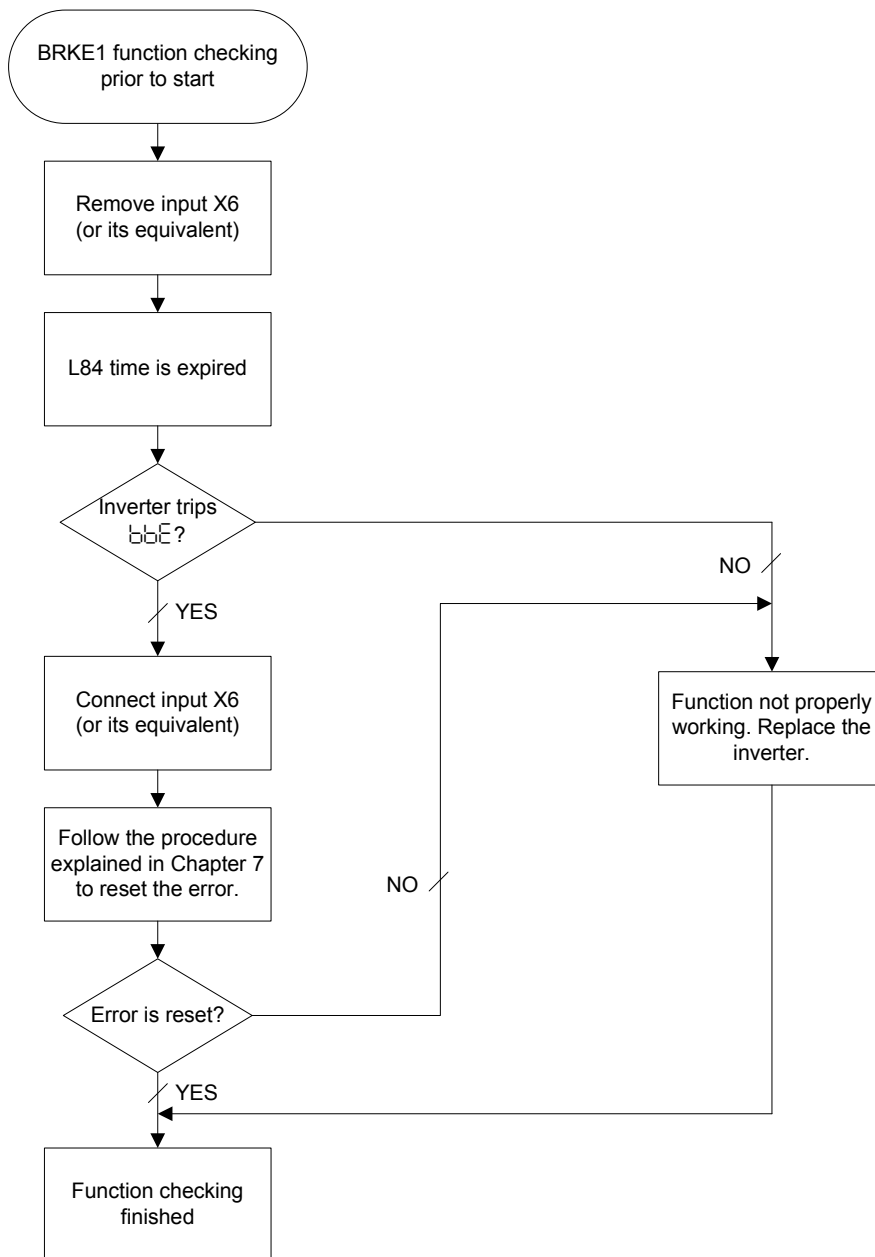

Figure 16. Test of BRKE1 function prior to start.

TEST OF BRKE2 FUNCTION

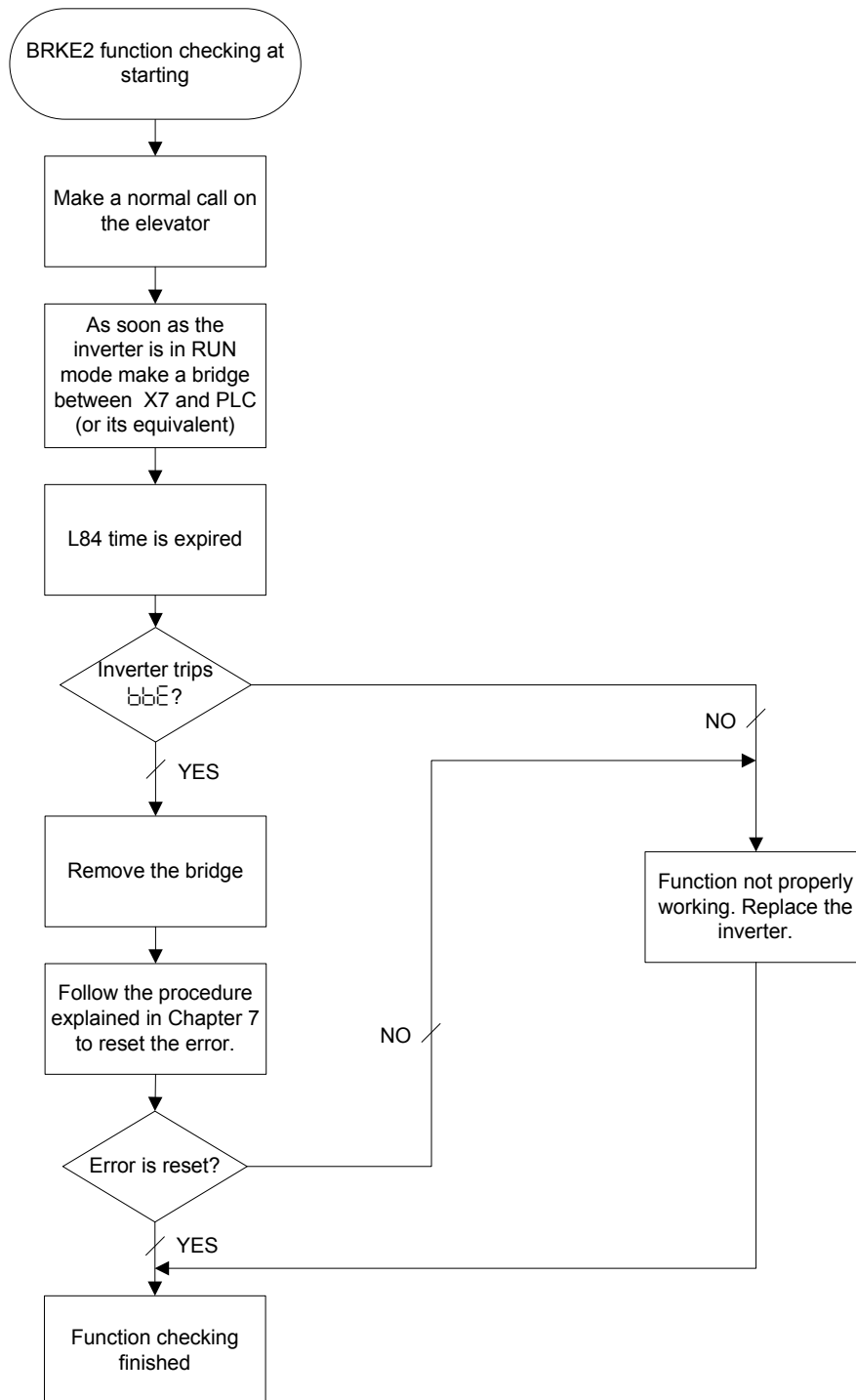

Figure 17. Test of BRKE2 function at starting.

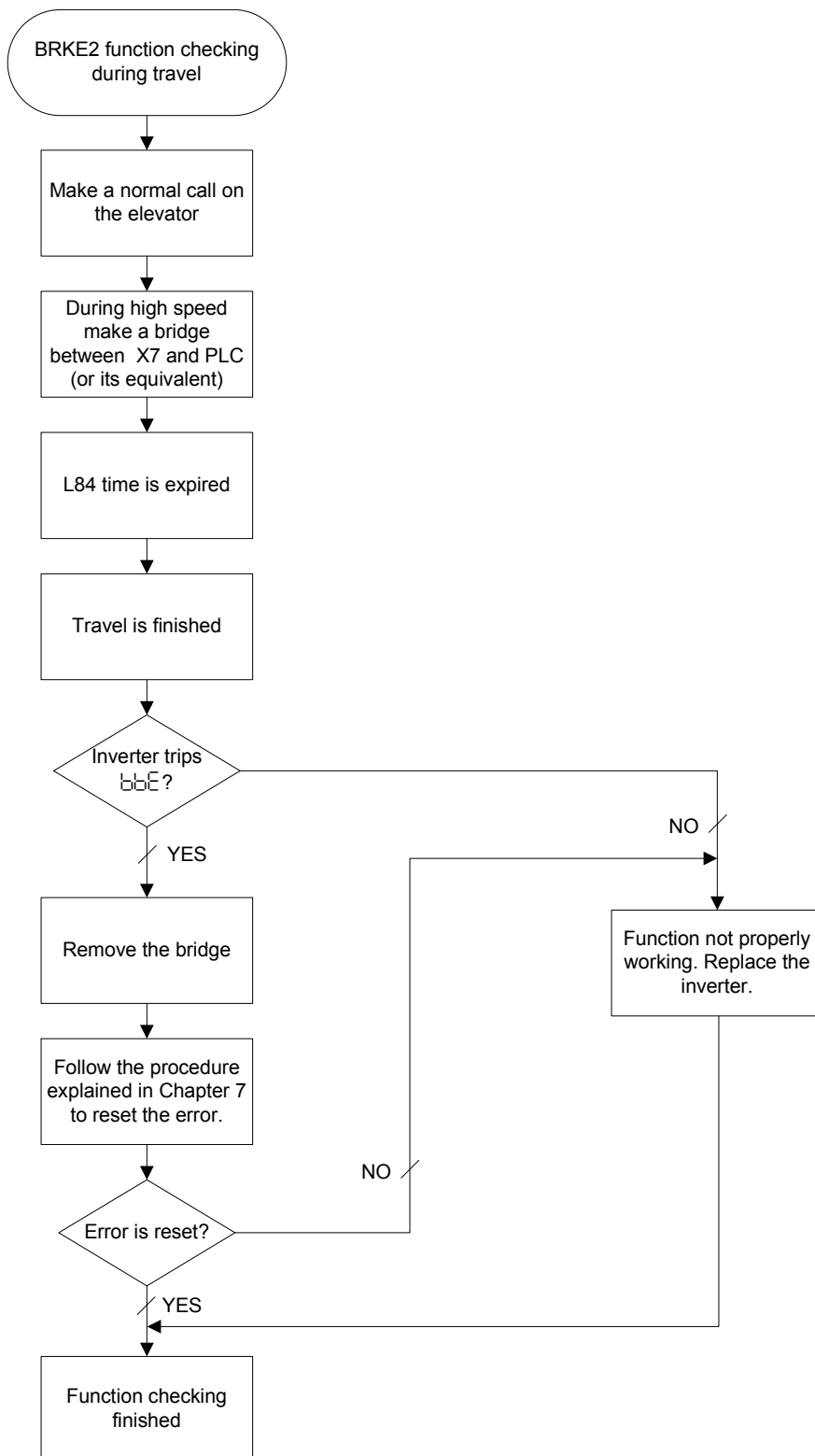

Figure 18. Test of BRKE2 function during normal travel.

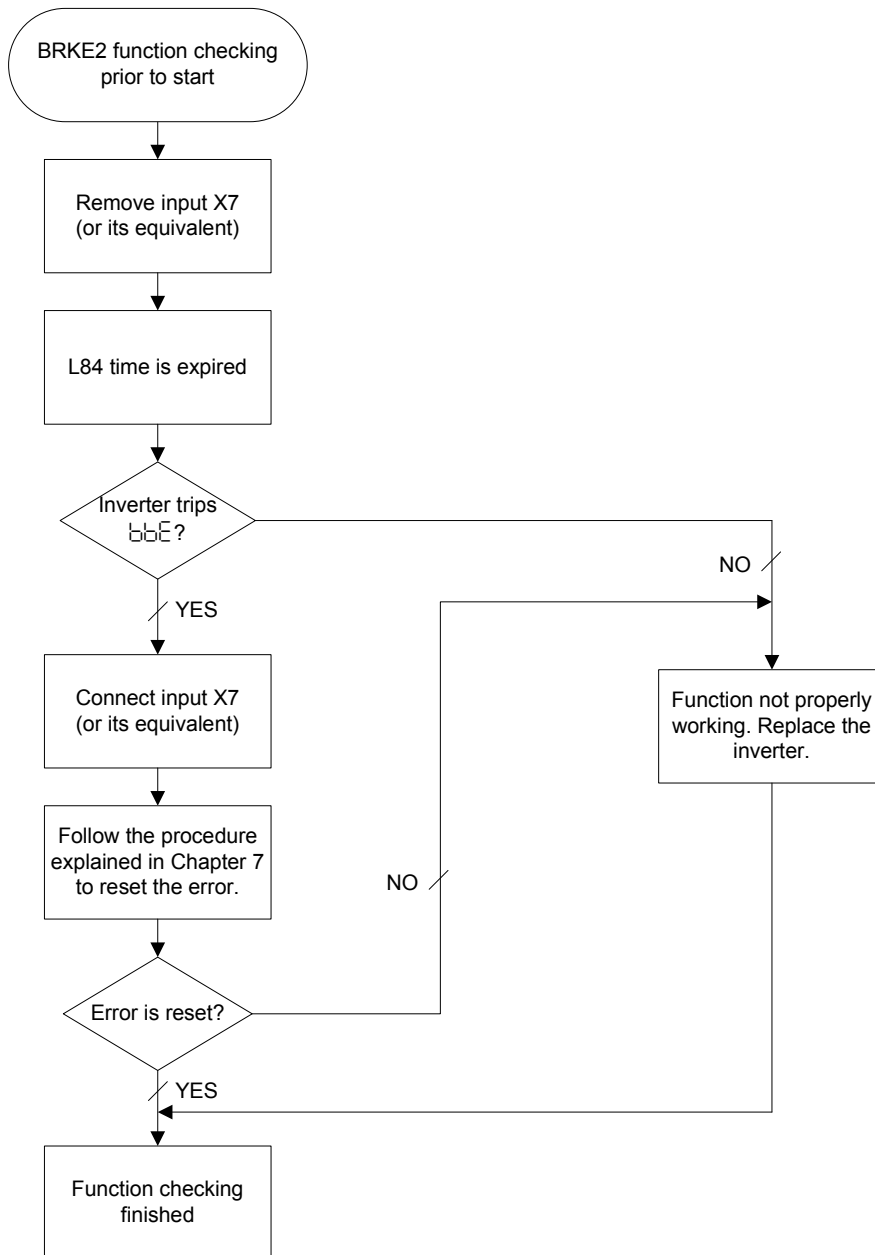

Figure 19. Test of BRKE2 function prior to start.

9. Conclusion

On this application note it is explained:

- How to use correctly FRENIC-Lift (LM2A) function related to UCM.
- How to recognize inverters which are provided with this function.
- How to test this function by the end user.

With this function, and using a motor with brakes well certified according to mentioned function, FRENIC-Lift (LM2A) can be used in an elevator in order to fulfil the requirements related to UCM.

In case of lifts with pre opening doors and/or re-levelling function, additional functional safety functions might be needed which will be implemented installing additional components.

10. Document history

Version	Changes applied	Date	Written	Checked	Approved
1.0.0	First version	16/01/2015	J. Alonso	J. Català	W. Visser